

Name: _____

-and

Write the words.

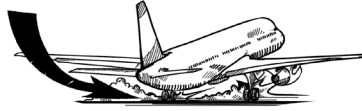

Color only the "and" words.

tumb

grand

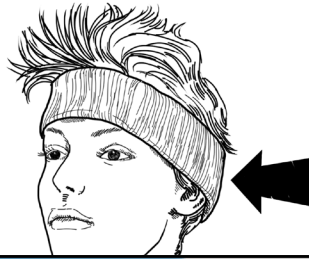

Preview

Please log in to download the printable version of this worksheet.

Color only the "and" words.

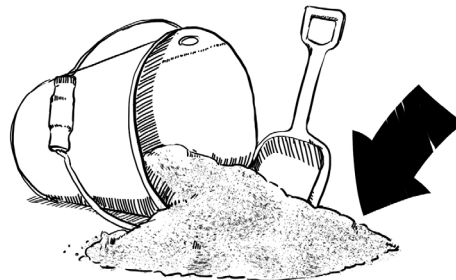
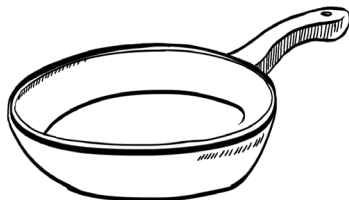
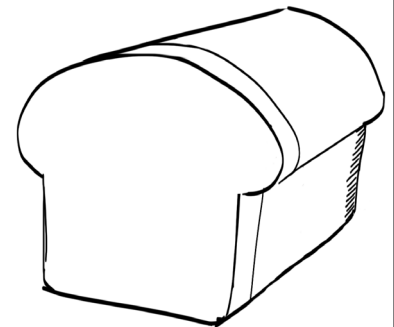
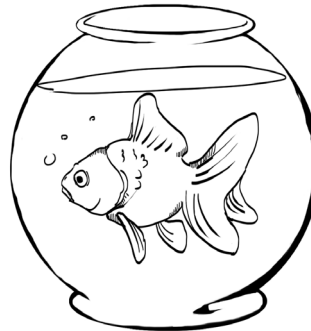
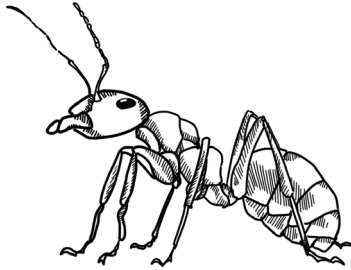

ANSWER KEY

-and

Write the words.

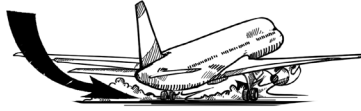

land

Color only the "and" words.



band



Preview

Please log in to download the printable version of this worksheet.

Color only the "and" words.

