

Name: _____

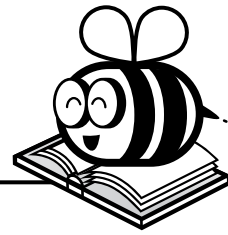

ELA Buzz

Add the correct punctuation to each sentence.

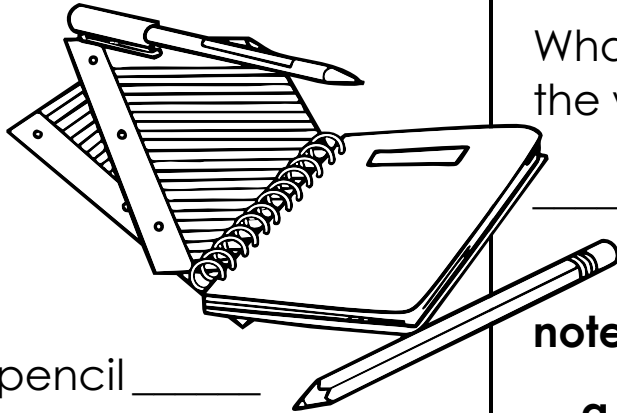

What two words make up the word **notebook**?

_____ and _____

What is the meaning of **notebook**?

- a. a book for writing notes
- b. a piece of paper

Where is my pencil _____

I can't find my notebook _____

I need to get a pen _____



Preview

Please log in to download the printable version of this worksheet.

- a. shouldn't
- b. shouldnt
- c. should'not
- d. shouldn't'



booc _____

pencil _____

noatbook _____

Adjectives are words that describe nouns. Circle the adjective in the sentence.

Adverbs are words that describe verbs. Underline the adverb in the sentence.

The friendly teacher asked us to talk quietly.



Name: _____



ELA Buzz



Fix the sentence. Then put a check next to the rule that explains the mistake.

Have you ever been apple picking.

- Common nouns are not capitalized.
- Proper nouns are capitalized.
- Statements end with a period.
- Questions end with a question mark.

Write the word that uses a silent



Circle the word that



_____ eating a peach for snack.
(I am)

apple picking.

_____ the fruit bowl?
(Where is)

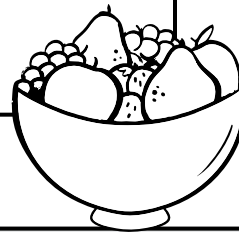

Write the plural form of each noun.

singular	strawberry	pear	peach
plural			

Use one of the plural nouns in a sentence.

Name: _____

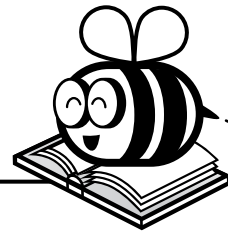

ELA Buzz

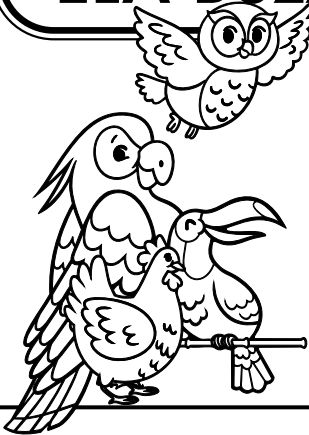

Put three commas in the sentence to make it correct.

Parrots chickens owls and toucans
are all kinds of birds.

Synonyms are words that have similar meanings.

What is the best synonym

Write the plural form of each noun on the line.

The _____ are sitting



Preview

Please log in to download the printable version of this worksheet.

c. branch

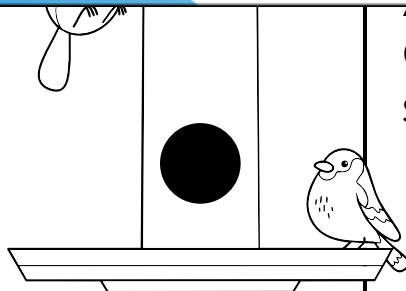

A possessive noun shows ownership.

Circle the possessive noun in the sentence.

The bird's wing was injured.

Complete each sentence with the correct homophone.

hear

here



"I think we should put the birdhouse _____," said Dad.

Mel can _____ the birds chirping.

Name: _____

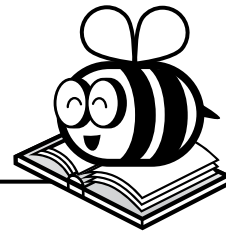

ELA Buzz

Consonant blends combine the sounds of two or three letters. Fill in the blanks with two letters to make a blend that matches the picture.

Sofia is ____ad her birthday is soon.

Mom made her a birthday ____own.

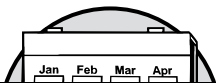

Draw a line to match

Write the two syllables in the boxes.



Preview

Please log in to download the printable version of this worksheet.

October • • Oct.

November • • Sept.

December • • Nov.

Adverbs are words that describe verbs. Underline the adverb in the sentence.

We sang "Happy Birthday" loudly.

Rewrite the sentence correctly.

maria and marco have Birthdays in december. **4 errors**

Name: _____



ELA Buzz

“What is in your lunch box today?” Will asked Kate.

Kate looked in her lunch box. “I have a ham sandwich and carrot sticks,” she said. “What is in your lunch box?”

“Tomato soup and a banana,” Will said. “And something else, too.”

“What is it?” Kate asked.

“I will give you a clue,” Will said.

“What is black and white and smells like flowers?”

“I don’t know,” Kate said. “What?”

“A skunk wearing perfume,” Will said.

“You have a skunk in your lunch box?” Kate said.

“No,” Will said. He showed Kate a piece of paper.

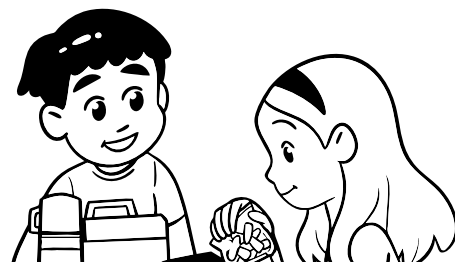

Preview

Please log in to download
the printable version of this worksheet.

Fill in the blank with a contraction.

_____ give you a clue.

(I will)

Write the number
of syllables on
the line.

sandwich _____

banana _____

tomato _____

carrot _____

Adjectives are words that describe nouns.
Complete the sentence using the
best adjective.

enchanting

delicious

happy

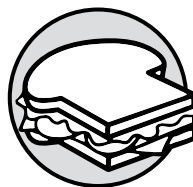

Kate ate a _____ sandwich.

Add the correct punctuation to each sentence.

Where is my pencil ?

I can't find my notebook .

I need to get a pen .

What two words make up the word **notebook**?

note and book

What is the meaning of **notebook**?

a. a book for writing notes

b. a piece of paper

Choose the correct contraction to complete the sentence.

You _____ talk when the teacher is talking.

a. shouldn't

b. shouldn't

Correctly spell the word on the line.

scool _____ school

booc _____ book

pencil _____ pencil

noatbook _____ notebook

Adjectives are words that describe nouns. Circle the adjective in the sentence.

Adverbs are words that describe verbs. Underline the adverb in the sentence.

The friendly teacher asked us to talk quietly.

Preview

Please log in to download the printable version of this worksheet.



Who are the two characters in this story?

Will and Kate

Where does this story take place?

in the school cafeteria

What surprise did Will find in his lunch box?

a joke

Write a contraction for the underlined words.

I'll give you a clue.
(I will)

Write the number of syllables on the line.

sandwich 2

banana 3

tomato 3

carrot 2

Adjectives are words that describe nouns. Complete the sentence using the best adjective.

enchanting delicious happy

Kate ate a delicious sandwich.