

Name: _____

St- Words

Cut out the words. Then glue them to the correct picture.

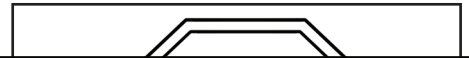
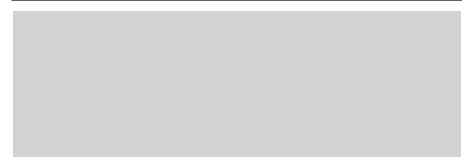
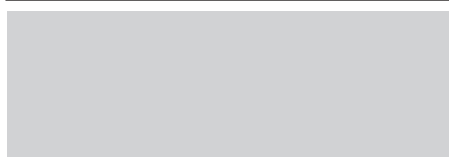
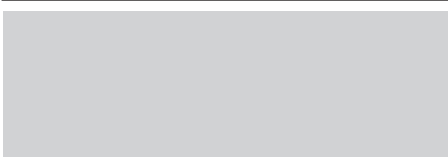
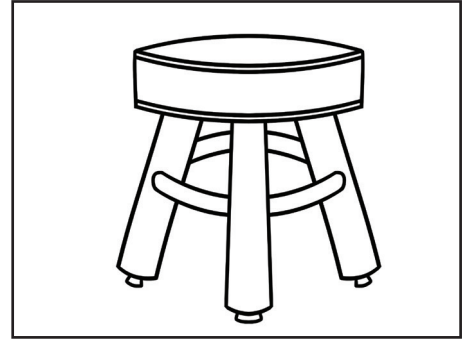
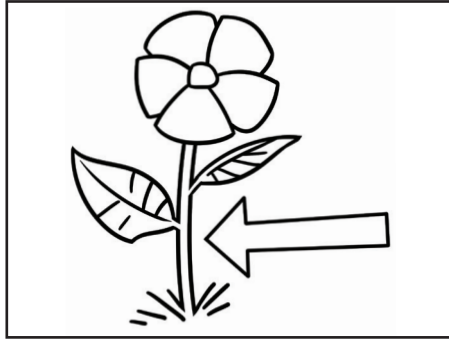
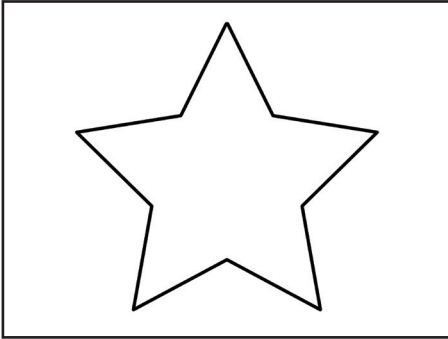

Preview
Please log in to download
the printable version of this worksheet.



stump

star

stool

stamps

stop

stem